

101 10 1003--,-
Mono 100 Surface Type 3

14W/ 19W /27W 240V-AC
Class III
IP20

Cable
Thickness: Max 8mm

LED Power Supply Included

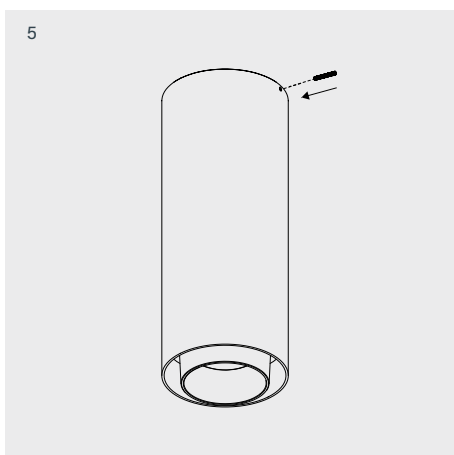
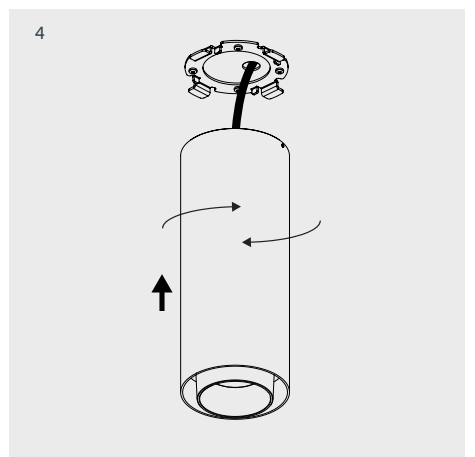
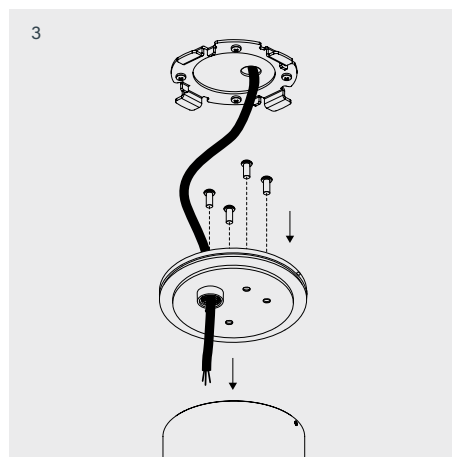
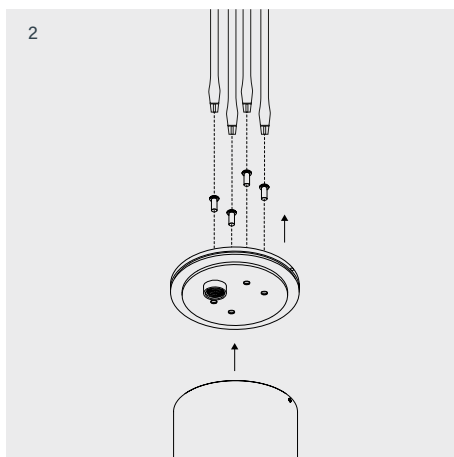
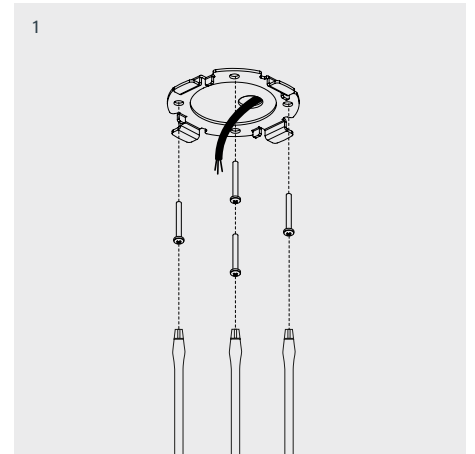
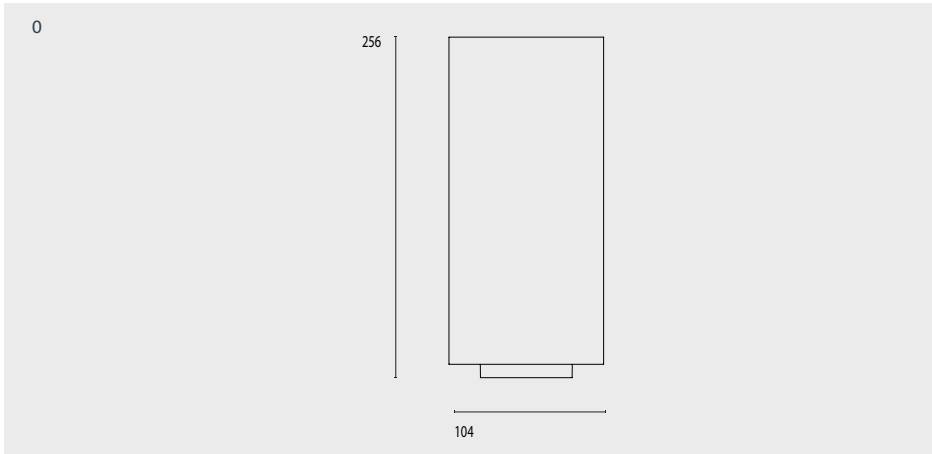

- 1 Place ceiling ring on the ceiling and fix it with supplied screws and anchors.
- 2 Remove the top four screws on the lid and detach the lid from the cylinder.
- 3 Bring power cable into the cylinder and terminate cable into the terminal block.
- 4 Slide Mono 100 Surface housing over the ceiling ring and rotate to lock into position.
- 5 Fix housing to ceiling ring with grub screw provided.